



Current Transformer Penetration type $\phi 10\text{mm}$ $\sim 100\text{A}$

TPCT-3410-100B Series

Code No.

· TPCT-3410-100B- * *

* * winding(30-3000turns, 25-2500turns, 20-2000turns)



Specification

Code No.	TPCT-3410-100B-30	TPCT-3410-100B-25	TPCT-3410-100B-20
Inner diameter	$\Phi 10\text{mm}$		
Turn ratio	1:3,000	1:2,500	1:2,000
Primary rated current	100 A		
Rated frequency	50/60Hz		
Rated load resistance	10 Ω		
Output characteristics ※1	0.33V	0.40V	0.50V
Phase angle ※1	Phase angle see figure.		
Operating temperature range	-40°C~80°C		
Withstand voltage	AC2000V(rms)/1minute		
Insulation resistance	DC500V/100M Ω Over		
※1 load resistance : 10 Ω			

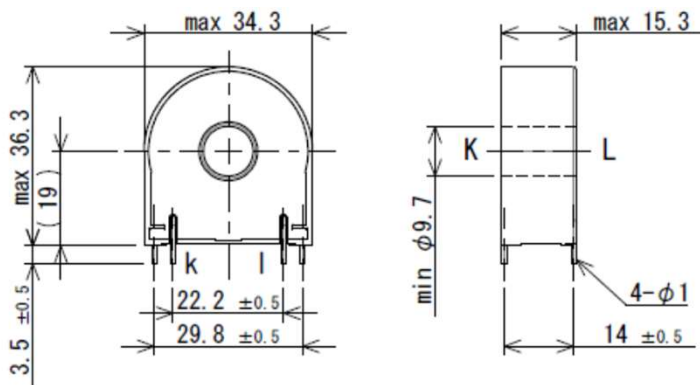

unit (mm)

Output terminals are ① and ②.

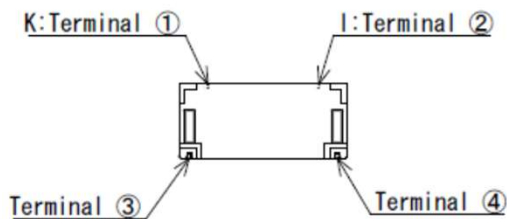

The terminal ③ and ④ are dummy. Use for soldering to printed boards.



Current Transformer Penetration type

Code No. TPCT-3410-100B-25, TPCT-3813-100B-25

Characteristic figure (2500turns)

